

Příslušenství pneumatických rozvodů z niklované mosazi

- kovové šroubení – fitinky – s galvanickým poniklováním
- přizpůsobeno k montáži s rychloupínacím systémem LF 3000 a LF 3600
- velký výběr různých provedení usnadňuje montáž pneumatických obvodů



Technické údaje	
Přípojovací závit	M5 1/8, 1/4, 3/8, 1/2, (metrický, válcový nebo kuželový)
Materiál	těleso: niklovaná mosaz, těsnění: mosaz nebo polymer H.F.
Rozsah tlaku:*	max. 60 bar
Rozsah teploty:*	-10°C až +80°C
Pracovní médium:	všechna média s přihlédnutím na odolnost použitých materiálů

* Max. pracovní teplota a tlak jsou závislé na vlastnostech a síle použité hadice tlakového obvodu.

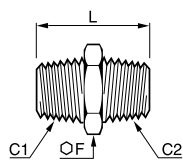

0900 Závítová vsuvka s kuželovým závitem

Typ	Objednací č.	C1	C2	F	L
DK-1818L	LE09000010	1/8	1/8	12	19,5
DK-1418L	LE09001013	1/8	1/4	14	23,5
DK-1414L	LE09000013	1/4	1/4	14	27
DK-3818L	LE09001017	1/8	3/8	17	24
DK-3814L	LE09001317	1/4	3/8	17	27,5
DK-3838L	LE09000017	3/8	3/8	17	28
DK-1214L	LE09001321	1/4	1/2	22	30,5
DK-1238L	LE09001721	3/8	1/2	22	31
DK-1212L	LE09000021	1/2	1/2	22	33,5
DK-3412L	LE09002127	1/2	3/4	27	37,5
DK-3434L	LE09000027	3/4	3/4	27	40
DK-1034L	LE09002734	3/4	1"	34	43
DK-1010L	LE09000034	1"	1"	34	45,5

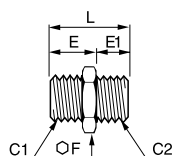

0901 Závítová vsuvka s válcovým závitem

Typ	Objednací č.	C1	C2	E	E1	F	L
DZ-55L	LE09010019	M5	M5	4	4	8	11,5
DZ-185L	LE09011910	M5	1/8	4	6	14	14,5
DZ-1818L	LE09010010	1/8	1/8	6	6	14	16,5
DZ-1418L	LE09011013	1/8	1/4	6	8	17	19
DZ-1414L	LE09010013	1/4	1/4	8	8	17	21
DZ-3814L	LE09011317	1/4	3/8	8	9	19	22
DZ-3838L	LE09010017	3/8	3/8	9	9	19	23
DZ-1238L	LE09011721	3/8	1/2	9	10	24	24,5
DZ-1212L	LE09010021	1/2	1/2	10	10	24	25,5

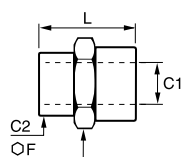

0902 Závítová objímka

Typ	Objednací č.	C1	C2	F	L
MU-55L	LE09020019	M5	M5	8	11
MU-185L	LE09021910	M5	1/8	14	13
MU-1818L	LE09020010	1/8	1/8	14	15
MU-1418L	LE09021013	1/8	1/4	17	19,5
MU-1414L	LE09020013	1/4	1/4	17	22
MU-3818L	LE09021017	1/8	3/8	22	20
MU-3814L	LE09021317	1/4	3/8	22	23
MU-3838L	LE09020017	3/8	3/8	22	24
MU-1214L	LE09021321	1/4	1/2	27	27
MU-1238L	LE09021721	3/8	1/2	27	27,5
MU-3412L	LE09022127	1/2	3/4	30	30
MU-3434L	LE09020027	3/4	3/4	30	32

0903 Redukční závitová vložka

Typ	Objednací č.	C1	C2	E
RN-1418L	LE09031013	1/4	1/8	8
RN-3814	LE09031317	3/8	1/4	9
RN-1238L	LE09031721	1/2	3/8	10
RN-3412L	LE09032127	3/4	1/2	14
RN-3410L	LE09032734	1"	3/4	20

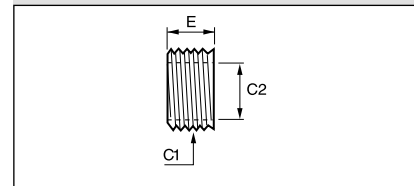
0904 Redukce s vnějším kuželovým závitem

Typ	Objednací č.	C1	C2	F	L
RNK-1418L	LE09041013	1/4	1/8	14	16
RNK-3818L	LE09041017	3/8	1/8	17	16,5
RNK-3814L	LE09041317	3/8	1/4	17	16,5
RNK-1214L	LE09041321	1/2	1/4	22	19,5
RNK-1238L	LE09041721	1/2	3/8	22	19,5
RNK-3438L	LE09041727	3/4	3/8	27	23,5
RNK-3412L	LE09042127	3/4	1/2	27	23,5

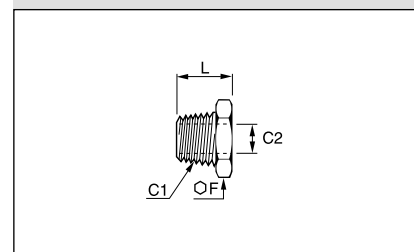

0905 Redukce s vnějším válcovým závitem

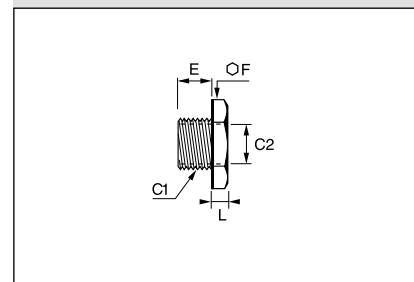
Typ	Objednací č.	C1	C2	E	F	L
RNZ-185L	LE09051910	1/8	M5	6	14	4,5
RNZ-1418L	LE09051013	1/4	1/8	8	17	5
RNZ-3818L	LE09051017	3/8	1/8	9	19	5
RNZ-3814L	LE09051317	3/8	1/4	9	19	5
RNZ-1214L	LE09051321	1/2	1/4	10	24	5,5
RNZ-1238L	LE09051721	1/2	3/8	10	24	5,5
RNZ-3438L	LE09051727	3/4	3/8	12	30	5,5
RNZ-3412L	LE09052127	3/4	1/2	12	30	5,5

0906 Redukční objímka

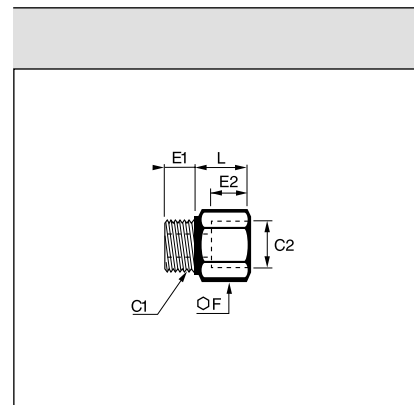
Typ	Objednací č.	C1	C2	E1	E2	F	L
RMZ-185L	LE09061019	M5	1/8	4	8	14	10
RMZ-1818L	LE09060010	1/8	1/8	6	8,5	14	10
RMZ-1418L	LE09061013	1/8	1/4	6	11,5	17	14
RMZ-3818L	LE09061017	1/8	3/8	6	11,5	22	14,5
RMZ-1414L	LE09060013	1/4	1/4	8	11,5	17	14
RMZ-3814L	LE09061317	1/4	3/8	8	11,5	22	14,5
RMZ-1214L	LE09061321	1/4	1/2	8	15	27	18
RMZ-3838L	LE09060017	3/8	3/8	9	11,5	22	14,5
RMZ-1238L	LE09061721	3/8	1/2	9	15	27	18
RMZ-1212L	LE09060021	1/2	1/2	10	15	27	18

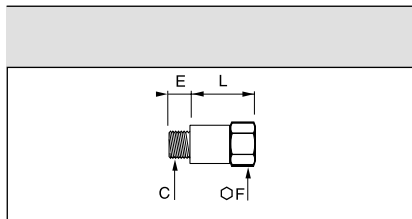



0907 Závité prodloužení

Typ	Objednáací č.	C	E	F	L
RMZL-18L	LE09070010	1/8	6	14	16
RMZL-18XL	LE0907001001	1/8	6	14	36
RMZL-14L	LE09070013	1/4	8	17	23
RMZL-14XL	LE0907001301	1/4	8	17	43

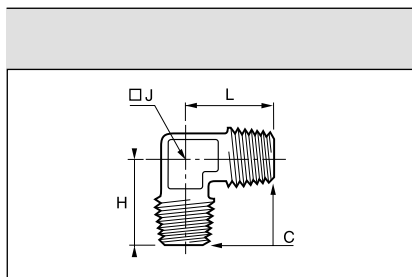

0914-0922 Úhlové šroubení s kuželovým závitem

Typ	Objednáací č.	C	H	J	L
WEA-18L	LE09140010	1/8	18,5	10	18,5
WEA-14L	LE09140013	1/4	23,5	13	23,5
WEA-38L	LE09140017	3/8	26	17	26
WEA-12L	LE09140021	1/2	31	21	31
WEA-34L	LE09140027	3/4	35	27	35
WEA-5L	LE09220019	M5	11	9	11

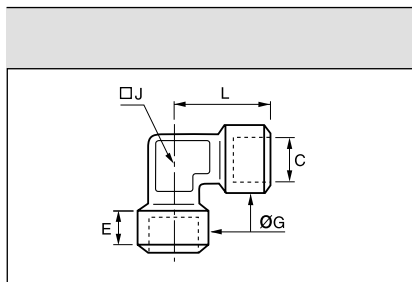

0912 Úhlové šroubení s vnitřním závitem

Typ	Objednáací č.	C	E	G	J	L
WII-5L	LE09120019	M5	4	8	9	11
WII-18L	LE09120010	1/8	8	13	10	21
WII-14L	LE09120013	1/4	11	17	13	25,5
WII-38L	LE09120017	3/8	11,5	21	17	28
WII-12L	LE09120021	1/2	14	26	21	33,5
WII-34L	LE09120027	3/4	15	31	27	36,5

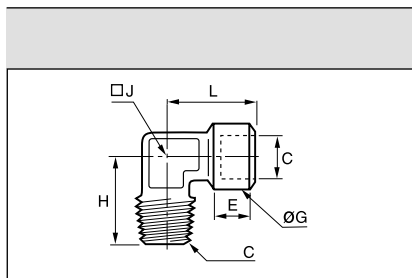

0913-0921 Úhlové šroubení s vnějším kuželovitým závitem

Typ	Objednáací č.	C	E	G	H	J	L
WEI-18L	LE09130010	1/8	8	13	18,5	10	21
WEI-14L	LE09130013	1/4	11	17	23,5	13	25,5
WEI-38L	LE09130017	3/8	11,5	21	26	17	28
WEI-12L	LE09130021	1/2	14	26	31	21	33,5
WEI-34L	LE09130027	3/4	15	31	35	27	36,5
WEI-5L	LE09210019	M5	4	8	11	9	11

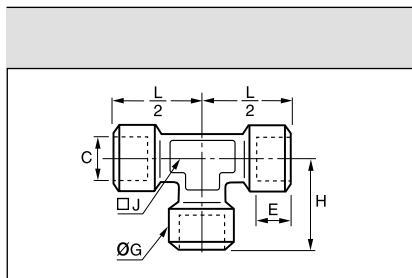

0915 T - šroubení s vnitřním závitem

Typ	Objednáací č.	C	E	G	H	J	L/2
TI-5L	LE09150019	M5	4	8	11	9	11
TI-18L	LE09150010	1/8	8	13	21	10	21
TI-14L	LE09150013	1/4	11	17	25,5	13	25,5
TI-38L	LE09150017	3/8	11,5	21	28	17	28
TI-12L	LE09150021	1/2	14	26	33,5	21	33,5
TI-34L	LE09150027	3/4	15	31	36,5	27	36,5

0916-0923 T - šroubení s vnějším kuželovým závitem

Typ	Objednáací č.	C	E	∅ G	H	J	L/2
TEA-5L	LE09230019	M5	4	8	11	9	11
TEA-18L	LE09160010	1/8	8	13	18,5	10	21
TEA-14L	LE09160013	1/4	11	17	23,5	13	25,5
TEA-38L	LE09160017	3/8	11,5	21	26	17	28
TEA-12L	LE09160021	1/2	14	26	31	21	33,5
TEA-34L	LE09160027	3/4	15	31	36,5	27	36,5

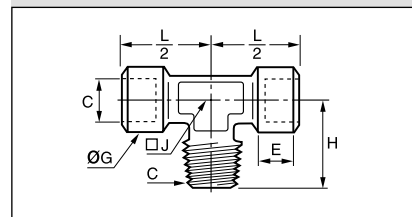
0917-0924 L - šroubení s kuželovým vnějším závitem

Typ	Objednáací č.	C	E	∅ G	H	J	L/2
LEA-5L	LE09240019	M5	4	8	11	9	11
LEA-18L	LE09170010	1/8	8	13	18,5	10	21
LEA-14L	LE09170013	1/4	11	17	23,5	13	25,5
LEA-38L	LE09170017	3/8	11,5	21	26	17	28
LEA-12L	LE09170012	1/2	14	26	31	21	33,5
LEA-34L	LE09170027	3/4	15	31	36,5	27	36,5

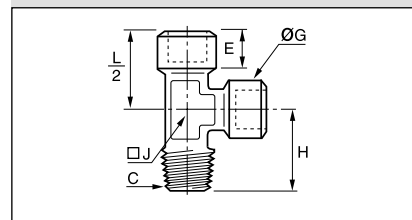
0909 Křížové šroubení s kuželovým vnějším závitem

Typ	Objednáací č.	C	E	∅ G	H	J
KEF-18L	LE09090010	1/8	8	13	18,5	10
KEF-14L	LE09090013	1/4	11	17	23,5	13
KEF-38L	LE09090017	3/8	11,5	21	26	17
KEF-12L	LE09090021	1/2	14	26	31	21

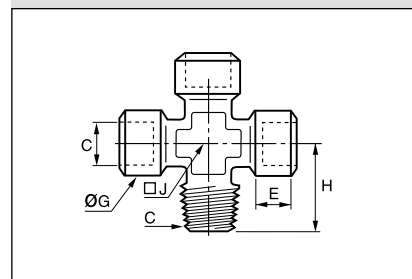

0908 Křížové šroubení s vnitřním závitem

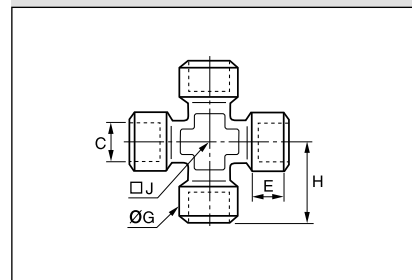
Typ	Objednáací č.	C	E	∅ G	H	J
KEI-18L	LE09080010	1/8	8	13	21	10
KEI-14L	LE09080013	1/4	11	17	25,5	13
KEI-38L	LE09080017	3/8	11,5	21	28	17
KEI-12L	LE09080021	1/2	14	26	33,5	21

0910 Y - šroubení s vnitřním závitem

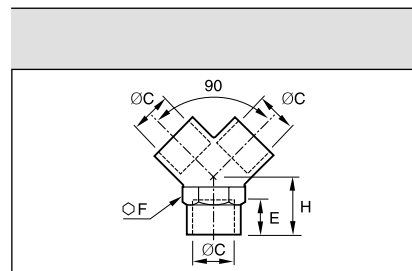
Typ	Objednáací č.	∅ C	E	F	H
YAA-18L	LE09100010	1/8	8	13	12
YAA-14L	LE09100013	1/4	11	17	14
YAA-38L	LE09100017	3/8	11,5	20	16
YAA-12L	LE09100021	1/2	14	25	19

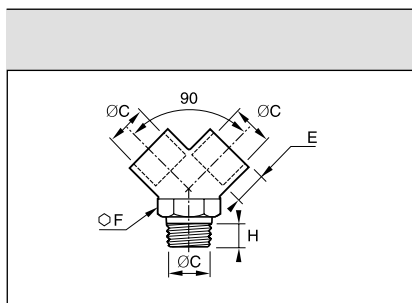



0911 Y - šroubení s vnitřním závitem

Typ	Objednáací č.	Ø C	E	F	H
YAI-18L	LE09110010	1/8	8	13	12
YAI-14L	LE09110013	1/4	11	17	14
YAI-38L	LE09110017	3/2	11,5	20	16
YAI-12L	LE09110021	1/2	14	25	19

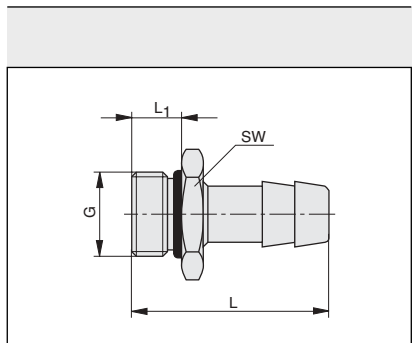

Vsuvky pro hadice (s O-kroužkem)

Údaje pro objednávku		Hadice Ø DI	Připojení G	L	L ₁	SW
Typ	Obj. číslo					
STO-184Msv	KW 0974	4	G1/8	31	6	15
STO-186Msv	KW 0439	6	G1/8	31	6	15
STO-146Msv	KW 0440	6	G1/4	33	8	18
STO-188Msv	KW 0442	8	G1/8	31	6	15
STO-148Msv	KW 0443	8	G1/4	33	8	18
STO-388Msv	KW 0444	8	G3/8	34	9	21
STO-149Msv	KW 0975	9	G1/4	33	8	18
STO-389Msv	KW 0976	9	G3/8	34	9	21
STO-1211Msv	KW 0447 ¹⁾	11	G1/2	36	11	26
STO-3813Msv	KW 0977	13	G3/8	39	9	21
STO-1213Msv	KW 0978	13	G1/2	41	11	26
STO-3413Msv	KW 0979	13	G3/4	45	14	32
STO-3419Msv	KW 0980	19	G3/4	48	14	32

Materiál: poniklovaná mosaz ¹⁾ výběhový typ

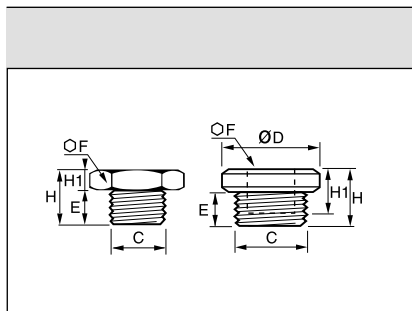

0919 Zátka s vnitřním šestihranem

Typ	Objednáací č.	C	Ø D	E	F	H	H1
VS-5L	LE09190019	M5	8	4	2,5	7,5	3,5
VS-18L	LE09190010	1/8	15	6	3	10	4
VS-14L	LE09190013	1/4	18	8	6	12	4
VS-38L	LE09190017	3/8	21	9	8	13	4
VS-12L	LE09190021	1/2	25	10	10	14,5	4,5
VS-34L	LE09190027	3/4		11	30	17	6
VS-10L	LE09190033	1		13	38	19	6

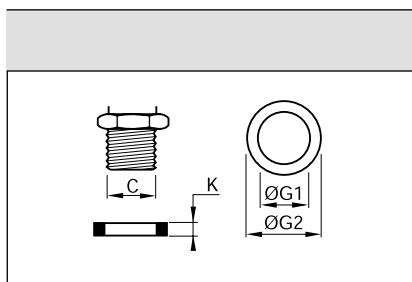

0138 Měděný kroužek

Typ	Objednáací č.	C	Ø G1	Ø G2	K
DI-18CVL	LE01381000	1/8	10,3	13,5	1
DI-14CVL	LE01381300	1/4	13,5	18	1,5
DI-38CVL	LE01381700	3/8	17,3	21	1,5
DI-12CVL	LE01382100	1/2	21,3	26	1,5
DI-34CVL	LE01382700	3/4	27,3	32	2
DI-10CVL	LE01383300	1"	33,5	39	2

0602 Plastové těsnění se zajištěním

Typ	Objednací č.	Ø G1	Ø G2	K
DI-M5KUL	LE0602299315	5,2	7,8	1,5
DI-18KUL	LE0602231020	10,3	14	2
DI-14KUL	LE0602231120	13,7	17,5	2
DI-38KUL	LE0602231220	17,2	21	2
DI-12KUL	LE0602231320	21,5	25,5	2,5
DI-34KUL	LE0602273220	27	32	2,5
DI-10KUL	LE0602306020	33,8	39	3

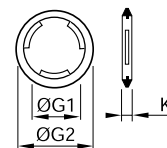

0920 Přepážkové šroubení

Typ	Objednací č.	C	C1	F	F1	K maxi	L1	L2	T mini
SON-M5L	LE09200019	M5	M10x1	14	14	7	10,5	3,5	10,5
SON-18L	LE09200010	1/8	M16x1,5	19	22	9	14	4	16,5
SON-14L	LE09200013	1/4	M20x1,5	24	27	15	21	4	20,5
SON-38L	LE09200017	3/8	M26x1,5	30	32	14	21	5	26,5
SON-12L	LE09200021	1/2	M28x1,5	32	36	20	27	6	28,5

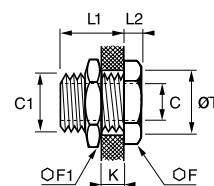

3312 Rozvodný blok

Typ	Objednací č.	C	H	L	L1	L2	L3	Ø T
VB-M5L	LE33120019	M5	20	20	10	12	12	4,5
VB-18L	LE33120010	1/8	30	30	16	23	22	4,5
VB-14L	LE33120013	1/4	40	40	20	30	27	5,5
VB-38L	LE33120017	3/8	50	50	25	38	39	6,5
VB-12L	LE33120021	1/2	50	50	25	38	39	6,5

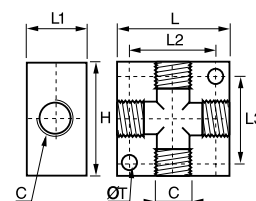

3311 Rozdělovací lišta

Typ	Objednací č.	C2	C1	počet výstupů	H	H1	H2	K	L	L1	L2	L3	M	ØT
VLE-1857L	LE3311191007	M5	1/8	7	4	20	10	10,5	95	15	21,5	52,5	16	5
VLE-14182L	LE3311101302	1/8	1/4	2	4,5	30	15	15,5	61	20	5,5	50	30	5
VLE-14183L	LE3311101303	1/8	1/4	3	4,5	30	15	15,5	91	20	30,5	30	30	5
VLE-14184L	LE3311101304	1/8	1/4	4	4,5	30	15	15,5	121	20	30,5	60	30	5
VLE-14185L	LE3311101305	1/8	1/4	5	4,5	30	15	15,5	151	20	30,5	90	30	5
VLE-14186L	LE3311101306	1/8	1/4	6	4,5	30	15	15,5	181	20	30,5	120	30	5
VLE-38142L	LE3311131702	1/4	3/8	2	6	30	11	19	74	20	6,5	61	36	6,5
VLE-38143L	LE3311131703	1/4	3/8	3	6	30	11	19	110	20	37	36	36	6,5
VLE-38144L	LE3311131704	1/4	3/8	4	6	30	11	19	146	20	37	72	36	6,5
VLE-38145L	LE3311131705	1/4	3/8	5	6	30	11	19	182	20	37	108	36	6,5
VLE-38146L	LE3311131706	1/4	3/8	6	6	30	11	19	218	20	37	144	36	6,5

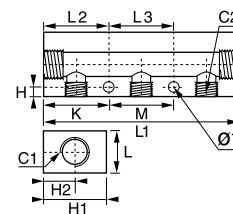

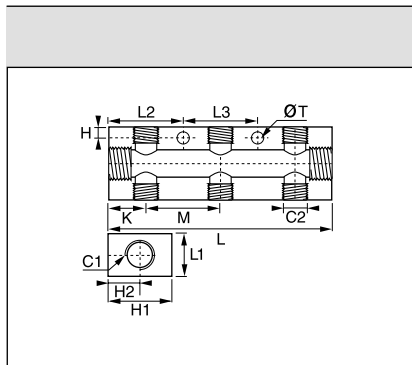

3313 Oboustranná rozdělovací lišta

Typ	Objednací č.	C2	C1	počet výstupů	H	H1	H2	K	L	L1	L2	L3	M	ØT
VLD-14182L	LE3313101302	1/8	1/4	2+2	4,5	30	15	15,5	61	20	5,5	50	30	5
VLD-14183L	LE3313101303	1/8	1/4	2+3	4,5	30	15	15,5	91	20	30,5	30	30	5
VLD-14184L	LE3313101304	1/8	1/4	2+4	4,5	30	15	15,5	121	20	30,5	60	30	5
VLD-14185L	LE3313101305	1/8	1/4	2+5	4,5	30	15	15,5	151	20	30,5	90	30	5
VLD-38142L	LE3313131702	1/4	3/8	2+2	6	40	20	19	74	20	6,5	61	36	6,5
VLD-38143L	LE3313131703	1/4	3/8	2+3	6	40	20	19	110	20	37	36	36	6,5
VLD-38144L	LE3313131704	1/4	3/8	2+4	6	40	20	19	146	20	37	72	36	6,5
VLD-38145L	LE3313131705	1/4	3/8	2+5	6	40	20	19	182	20	37	108	36	6,5
VLD-12143L	LE3313132103	1/4	1/2	2+3	6	40	20	22	116	28	40	36	36	6,5
VLD-12144L	LE3313132104	1/4	1/2	2+4	6	40	20	22	152	28	40	72	36	6,5
VLD-12145L	LE3313132105	1/4	1/2	2+5	6	40	20	22	188	28	40	108	36	6,5

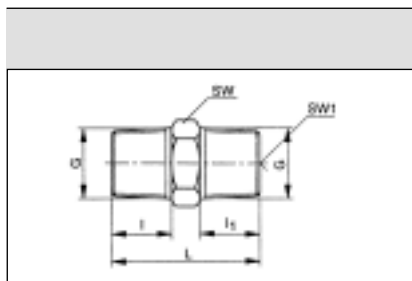

Dělitelná spojka (3-dílná) s kuželovým závitem

Typ	Objednací č.	G	I	I1	L	SW	SW1
DT-1818	KY 6364	G1/8 kuž.	9	9	27	15	5
DT-1814	KY 6365	G1/4 kuž.	12	12	34	19	6
DT-3838	KY 6366	G3/8 kuž.	13	13	36	22	8
DT-1212	KY 6367	G1/2 kuž.	16	16	44	27	12
DT-3434	KY 6368	G3/4 kuž.	18	18	52	36	14
DT-1010	KY 6369	G1 kuž.	18	22	65	46	19

Uzavírací matka					
Údaje pro objednávku		G	SW	l	L
Typ	Obj. číslo				
UM-18Msv	KW 0435	G1/8	14	7,0	12,0
UM-14Msv	KW 0436	G1/4	17	8,0	14,0
UM-38Msv	KW 0437	G3/8	20	10,3	16,0
UM-12Msv	KW 0438	G1/2	24	11,4	19,0

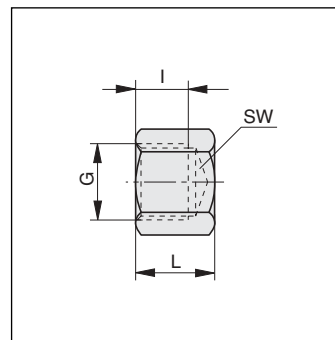
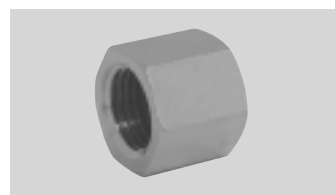

Těsnící kroužky						
Údaje pro objednávku		pro velikost připojení	$\varnothing D_1$	$\varnothing D_2$	s	Materiál
Typ	Obj. číslo					
Těsnící kroužky z hliníku						
DI-5AL	KZ 7669	M5	5	7,5	1	hliník
DI-18AL	KW 0349	G1/8	10	14	1,5	hliník
DI-14AL	KW 0350	G1/4	13,2	18	1,5	hliník
DI-38AL	KW 0351	G3/8	17	21	1,5	hliník
DI-12AL	KW 0352	G1/2	21	26	1,5	hliník
DI-34AL	KZ 7865	G3/4	26,5	31	2	hliník
DI-10AL	KZ 7866	G1	33,5	39	1,0	hliník
Těsnící kroužky plastové						
DI-5KU	KW 0582	M5	5	7,5	1	tvrdé PVC
DI-18KU	KW 0354	G1/8	10	14	1,5	tvrdé PVC
DI-14KU	KW 0355	G1/4	13,2	18	1,5	tvrdé PVC
DI-38KU	KW 0356	G3/8	17	21	1,5	tvrdé PVC
DI-12KU	KW 0357	G1/2	21	26	1,5	tvrdé PVC
Těsnící kroužky z mědi						
DI-5CU	KW 0583	M5	5	7,5	1	měď
DI-18CU	KW 0584	G1/8	10	14	1,5	měď
DI-14CU	KW 0585	G1/4	13,5	18	1,5	měď
DI-38CU	KW 0586	G3/8	17	21	1,5	měď
DI-12CU	KW 0587	G1/2	21	26	1,5	měď

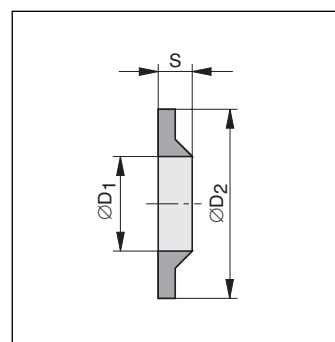
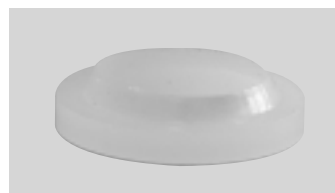
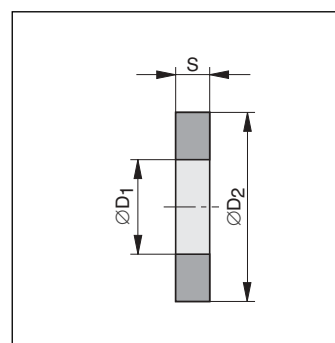
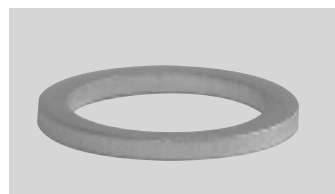

Těsnící kroužek pro manometr						
Údaje pro objednávku		pro velikost připojení	$\varnothing D_1$	$\varnothing D_2$	s	Materiál
Typ	Obj. číslo					
MD-18	KZ 7430	G1/8	9,4	15	4,2	umělá hmota
MD-14	KZ 7431	G1/4	12,8	18,6	4,5	Kunststoff

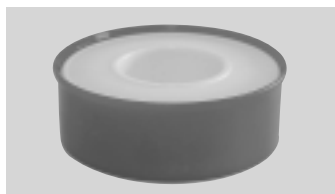

Závitová těsnicí páska			
Údaje pro objednávku		Tloušťka	Délka
Typ	Obj. číslo		
GD-128	KY 9426	0,08 mm	12 m



Zátka s vnitřním šestihranem (s O-kroužkem)						
Údaje pro objednávku		G	SW	Ø D	l	L
Typ	Obj. číslo					
VS-5Msv	KW 0425	M5	2,5	8	4	6,5
VS-18Msv	KW 0426	G1/8	3	15	7	9,5
VS-14Msv	KW 0427	G1/4	6	18	8	11
VS-38Msv	KW 0428	G3/8	8	21	9	12,5
VS-12Msv	KW 0429	G1/2	10	26	11	14,5

